

Article number: 204060M840A0S

Description: E+G levelling foot
GN 40-60-M8-40-A0-S

Note: S Without nut, External hexagon at the bottom

Measures

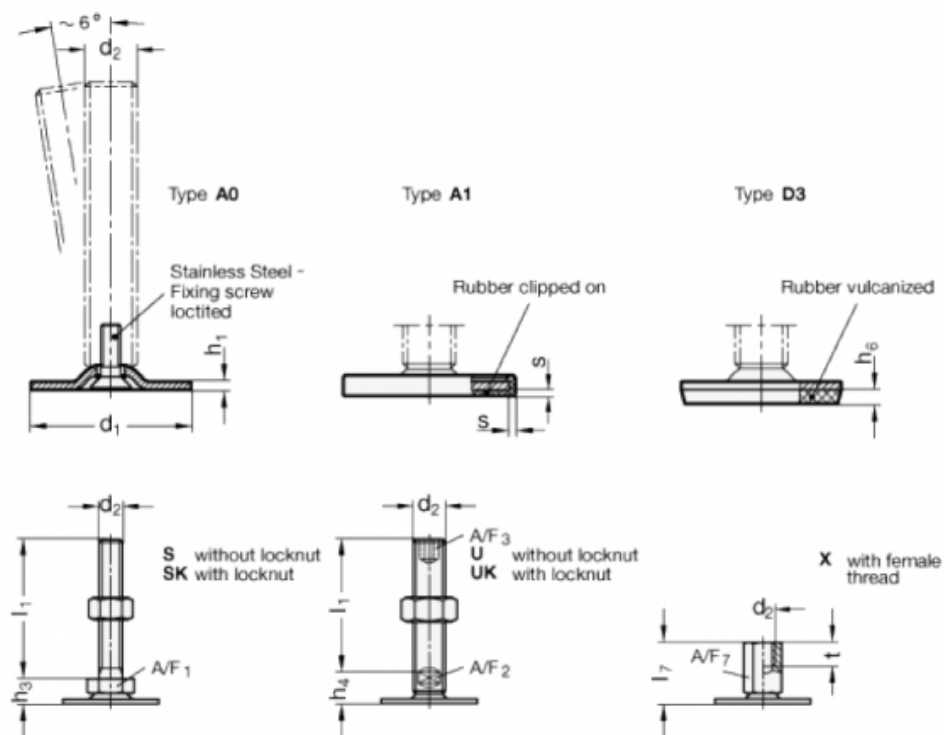

A/F1	= 17
d1	= 60
d2	= M8
h1	= 2.5
h3	= 11
h6	=
l1	= 40
s	=